

## Effect of steam injection in Intercooling and Heat Regenerative Gas Turbine cycle IHSTIG

<sup>1</sup>Eng. Hisham AlGraiw <sup>2</sup>Eng. Ahmed Alajely <sup>3</sup>Eng. Abd Almenem Shaban

<sup>1,2,3</sup> College of Engineering Technology, Janzour, Libya

### Abstract

It is known that the efficiency of gas turbines is low, especially when operating in harsh conditions such as high air temperature. Therefore, the performance of gas turbines has been improved by intercooling and heat regenerative. In this work, the possibility of improving efficiency and production capacity was studied by injecting steam into the combustion chamber of a gas turbine, in the presence of intercooling and heat regenerative, the cooling process is carried out by pumping water to cool the compressor, so that it turns into steam, which is then injected into the combustion chamber after passing through a heat recovery steam generator HRSG. The focus has been on the study of the change in the ratio of water to air, as well as the amount of intercooling. The results showed that there is a possibility to raise the efficiency and production capacity at a high water-air ratio, the temperature of the combustion gases has decreased, which helps the turbine blades to withstand, and the production of nitrogen oxides polluting the environment has decreased.

**Key words:** Gas turbine; Steam injection; Intercooling; Regenerative; Nitrogen Oxides

### 1.Introduction

Gas turbine engines have proven to be very successful in generating power and have been widely used in many industrial fields, but these engines are disadvantaged by their low efficiency, for this they have been developed and studies are still ongoing. One of the most important previous developments is the cycle of intercooling and heat regenerative [1]. Recently being studied to raise its efficiency by injecting steam into the combustion chamber [2]. Frutschi and Plancherel [3]. studied steam injection into the combustion chamber of the simple cycle of gas turbine (STIG), so that steam is generated by the exhaust gas using a heat recovery steam generator HRSG. A development of the STIG cycle is the intercooled steam injection cycle (ISTIG), the essential feature of the ISTIG is to obtain increased turbine work [2]. Lloyd. [4] developed a STIG by adding a recuperator to heat the air coming out of the compressor. In this work, the effect of steam injection into the combustion chamber with intercooling and heat recuperator (IHSTIG) was studied, so that water is pumped in the intercooling process and then passed through the heat recovery steam generator HRSG and injected as steam into the combustion chamber. A thermodynamic analysis of the cycle and a computational model was prepared to study and analyze the interrelating variables. The results were presented in the form of comparative curves, and the study ended with an important conclusion.

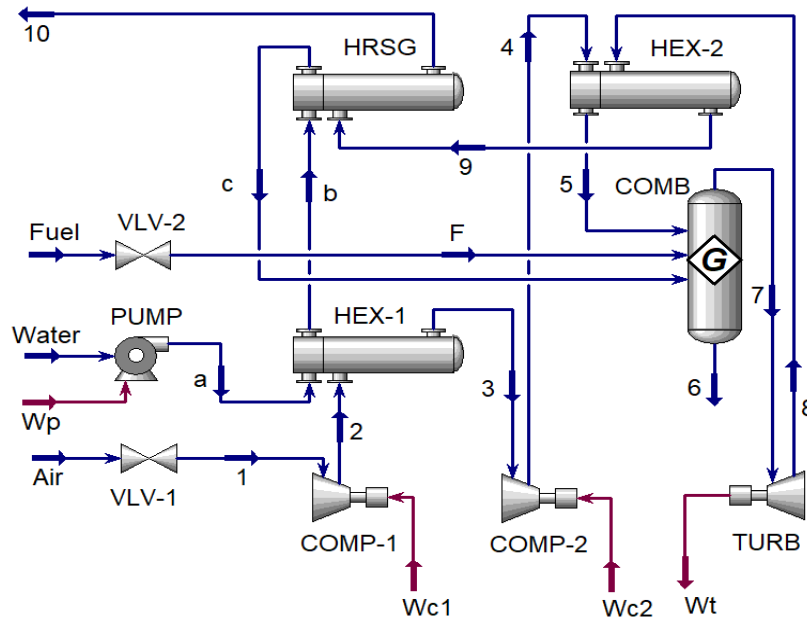

Fig.1 A schematic diagram of the Intercooled Heat Regenerative Steam Injection Gas Turbine Cycle (IHSTIG)

## 2. Description of the Intercooling Heat Regenerative Steam Injection Gas Turbine Cycle (IHSTIG)

Generally, in IHSTIG, shown in Figure 1, air enters the first compressor COMP-1 in atmospheric conditions to leave when its pressure rises to the design value at high temperature, where it is cooled in the first heat exchanger HEX-1 by water which is also pumped to the first heat exchanger, the air is cooled, the water is heated and turns into saturated steam, air leaves the first heat exchanger and enters the second compressor COMP-2, where its pressure rises to the maximum pressure designed for the cycle, then enters the second heat exchanger HEX-2, where it is heated, taking advantage of the heat exchange with the gases leaving the turbine that also entered the second heat exchanger. The air leaves to the combustion chamber COMB at high pressure and high temperature, and the flue gas enters the heat recovery steam generator HRSG to exchange heat with the saturated steam that came from the first heat exchanger. The temperature of the exhaust gas decreases before leaving to the atmosphere, and the enthalpy of steam rises and leaves the heat recovery steam generator HRSG and is injected into the specially designed combustion chamber to burn gas, air and steam [5]. The flue gas leaves the combustion chamber to the gas turbine TURB at very high pressure and temperature, where it expands in the turbine to generate the required energy and leaves to the second heat exchanger where it completes the mentioned path and the cycle ends.

### 3. Thermodynamic Model and Analysis

#### 3.1 Model Assumptions

During the analysis of this study, the following assumptions have been made:

- Atmospheric conditions are taken as temperature 298 K, pressure 1.01 bar
- Isentropic efficiencies of both the compressor and the gas turbine 85%, 85% respectively
- Pump isentropic efficiency 75%.
- Pump work is neglected.
- Compositions of Natural Gas as Fuel:

86.482% CH<sub>4</sub>, 10.392% C<sub>2</sub>H<sub>6</sub>

0.496% C<sub>3</sub>H<sub>8</sub>, 0.014% i-C<sub>4</sub>H<sub>10</sub>

2.023% CO<sub>2</sub>, 0.593% N<sub>2</sub>

- Pressure ration of both the compressor-1 and compressor-2 are 9, 9, respectively
- Air flowrate 100 kg/s, fuel flowrate 2kg/s and steam flowrate will increase and decrease in order to study its effect in overall performance.
- Pressure drops in the combustion chamber, HEX-1, HRSG and HEX-2 are neglected.

#### 3.2 Thermodynamics Analysis

- For the Heat exchanger HEX-1

$$(h_{a2} - h_{a3}) = S(h_{sb} - h_{sa}) \quad (1)$$

- For the Heat exchanger HRSG

$$(1 + f)(h_{g9} - h_{g10}) + S(h_{s9} - h_{s10}) = S(h_{sc} - h_{sb}) \quad (2)$$

- For the Heat exchanger HEX-2

$$(1 + f)(h_{g8} - h_{g9}) + S(h_{s8} - h_{s9}) = (h_{a5} - h_{a4}) \quad (3)$$

- For the combustion process in the combustion chamber COMB

$$(h_{a5} - h_{a0}) + fCV = (1 + f)(h_{g7} - h_{g0}) + S(h_{s7} - h_{sc}) \quad (4)$$

*Substitute 1,2,3 in 4*

$$fCV = (1 + f)(h_{g7} - h_{g8}) + S(h_{s7} - h_{s8}) - (h_{a2} - h_{a0}) - (h_{a4} - h_{a3}) + (1 + f)(h_{g10} - h_{g0}) + S(h_{s10} - h_{sa}) \quad (7)$$

Let:

$$W_t = (1 + f)(h_{g7} - h_{g8}) + S(h_{s7} - h_{s8}) \quad (8)$$

$$W_{c1} = (h_{a2} - h_{a1}) \quad (9)$$

$$W_{c2} = (h_{a4} - h_{a3}) \quad (10)$$

$$\text{Neglect } w_p \text{ then: } h_{sa} = h_{s0} \quad (11)$$

$$\text{Neglect Valve-1 then: } h_{a1} = h_{a0} \quad (12)$$

*Sub 8,9,10,11,12 in 7*

$$fCV = W_t - W_{c1} - W_{c2} + (1 + f)(h_{g10} - h_{g0}) + S(h_{s10} - h_{s0}) \quad (13)$$

$$\therefore \eta = \frac{W_t - W_{c1} - W_{c2}}{fCV} \quad (14)$$

*Sub 14 in 13*

$$1 = \eta + \frac{(1+f)(h_{g10} - h_{g0}) + S(h_{s10} - h_{s0})}{fCV} \quad (15)$$

$$\therefore \eta = 1 - \frac{(1+f)(h_{g10} - h_{g0}) + S(h_{s10} - h_{s0})}{fCV} \quad (16)$$

#### 4. Analysis of the results

In this system, the process of cooling the air entering compressor Com-2, what is known as the intercooling process takes place by pumping water to the heat exchanger HEX-1, where it exchanges heat with the hot air produced by the first compressor Com-1 and leads to its cooling. When the water flow rate to the heat exchanger is low, it quickly turns into superheated steam at a high temperature, and the higher the water flow rate, the lower the temperature of the outgoing steam until it reaches the saturated steam, as shown in Figure 2

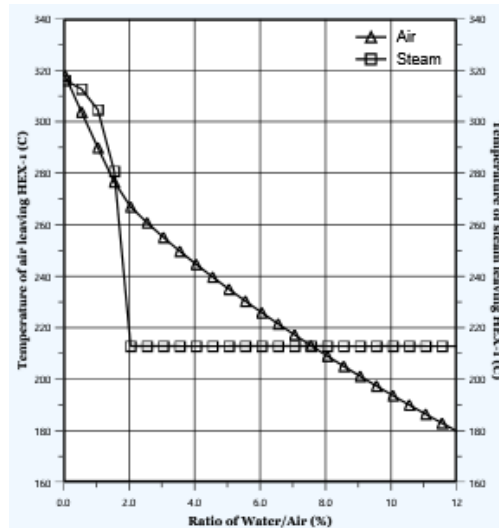

Figure 2 Steam & Air temperature outgoing from HEX-1 vs Water/Air ratio

The decrease in the temperature of the air entering the second compressor leads to a decrease in the energy required to operate it as shown in Figure 3. This improvement continues as the water flowrate increases to the heat exchanger, but this does not apply to the turbine, as without pumping water, the turbine's energy production is high. However, the steam injection process in the combustion chamber leads to a decrease in its temperature, as shown in Figure 4, which reduces the enthalpy of the gases entering the gas turbine and leads to a decrease its production capacity, but with the continued increase of the steam injection rate, the overall flow rate of the gases entering the turbine increases, which enhances its production capacity and makes it rise gradually.

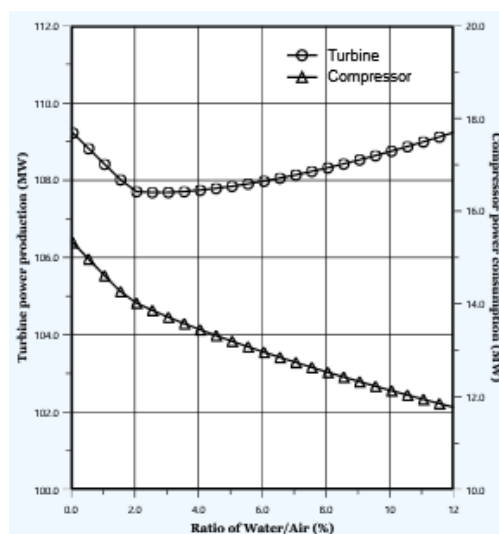

Figure 3 Power Turbine production & Compressor consumption vs Water/Air ratio

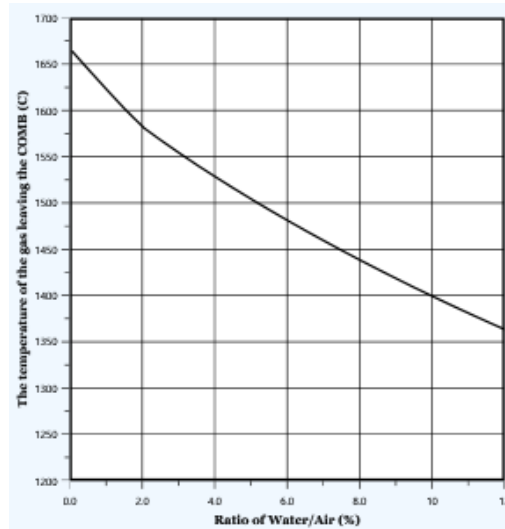

Figure 4 Combustion gas temperature vs Water/Air ratio

Despite the decrease in the energy required to operate the compressor, the net production capacity decreases as the water pumping rate increases to a certain limit, then gradually improves after exceeding this limit, this improvement is due to the improvement in the production capacity of the gas turbine, which leads to an improvement in the overall efficiency of the cycle after decreased at a low steam injection rate, as it is shown in Figure 5, the efficiency behaves the same way as the net productive capacity, considering that the fuel flowrate is constant. The figure shows that the efficiency increased by 5.6% at a water/air ratio 12%.

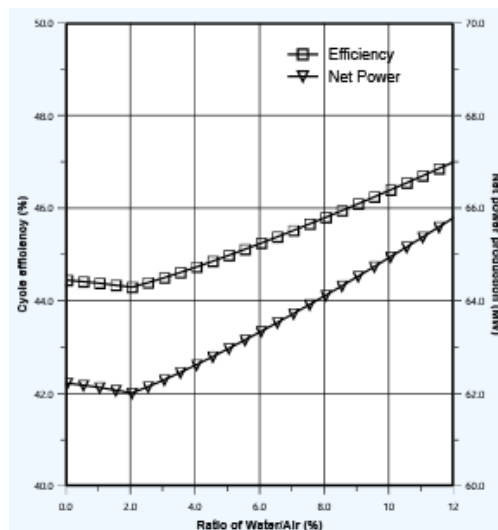

Figure 5 Cycle efficiency & Net power produced vs Water/Air ratio

Referring to Figure 4. The decrease in the temperature of the flue gas leads to the support of the turbine blades to withstand. It allows the use of blades with a simple engineering design [6], as well as leads to a reduction in the rate of production of nitrogen oxides polluting the environment. It is known that these oxides are produced at very high temperatures [7]. Figure 6 shows a decrease in the production of nitrogen monoxide and nitrogen dioxide as the rate of steam injection increases.

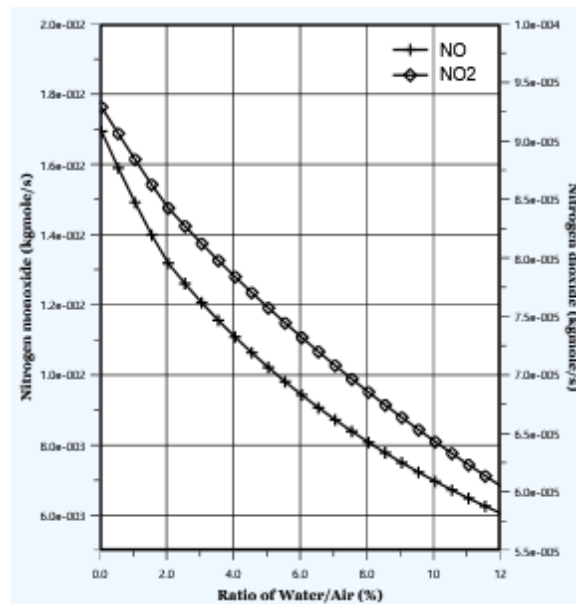

Figure 6 Nitrogen monoxide and Nitrogen dioxide production vs Steam flowrate

The intercooling process of the compressor produced a decrease in the energy required to operate it, but this caused an increase in the temperature of the water entering to the heat recovery steam generation HRSG, and led to its inability to absorb the heat of the exhaust gas and led to an increase in the amount of heat loss. Figure 7 shows Reducing the intercooling rate leads to lowering the exhaust gas temperature and thus raising the overall efficiency of the cycle for water/air ratio 6%. This result is consistent with Equation (6), where this equation shows that reducing the enthalpy of the exhaust gas leads to an increase in the efficiency of the cycle.

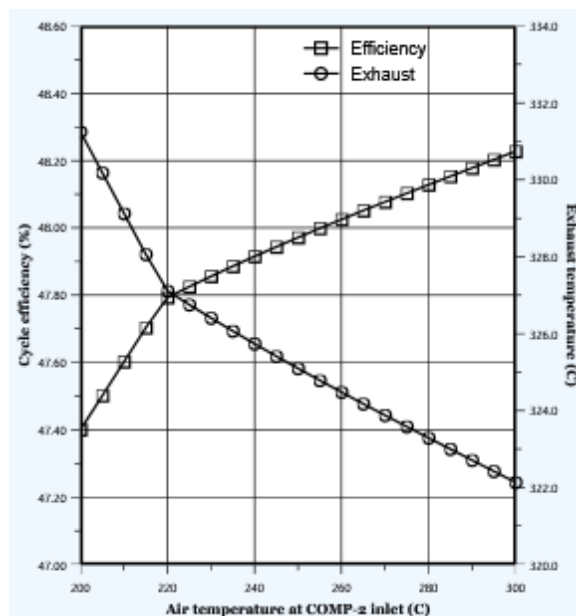

Figure 7 Cycle efficiency and Exhaust temperature vs Air temperature at entering COMP-2

## 5. Conclusion

- This study showed that injecting steam in small quantities into gas turbine engines with intercooling and heat recovery leads to a decrease in net power and cycle efficiency, however, increasing steam injection at a large rate improves the net power and efficiency, but it is impractical in some engines such as aircraft engines.
- The injection of steam in a large amount led to a reduction in the temperature of the combustion gases, which helps to preserve the gas turbine blades and expand the use of several types of blades with a simple design.
- Reducing in the temperature of combustion gases helped reduce the rate of production of nitrogen oxides that pollute the environment, such as nitrogen monoxide and nitrogen dioxide.
- Intercooling process led to rise up the temperature of steam entering to the heat recovery steam generator HRSG, which reduce its ability to absorb heat from exhaust gas and led to decrease the cycle efficiency.

### Nomenclature

$h_a$	Air enthalpy
$h_s$	Steam enthalpy
$S$	Steam flowrate
$f$	Fuel flowrate
$CV$	Fuel calorific value
$W_c$	Turbine work
$W_t$	Compressor work
$\eta$	Thermal efficiency



## 6. References

1. Fundamentals of Thermodynamics, Borgnakke, Sonntag, 8th edition, John Wiley & Sons, 2013
2. Advanced gas turbine cycles, Horlock, 1st edition, Elsevier Science Ltd, 2003
3. Frutschi, H.U. and Plancherel, A.A. Comparison of combined cycles with steam injection and evaporation cycles, ASME Cogen-Turbo, (1988).
4. Lloyd, A Thermodynamics of chemically recuperated gas turbines. CEES Report, Princeton University Library. (1991).
5. Rui, Chunbo, Vishal, Theoklis, Pericle, Effect of steam addition on gas turbine combustor design and performance, Applied Thermal Engineering, 2016
6. Cleeton, Kavanagh, Parks, Blade cooling optimisation in humid-air and steam-injected gas turbines, Applied Thermal Engineering, 2009
7. A. Farokhipour, E. Hamidpour, E. Amani, A numerical study of NO<sub>x</sub> reduction by water spray injection in gas turbine, Elsevier Ltd. Fuel 212(2018)

