

# Low Cost IMU \ GPS Integration Using Kalman Filtering for Land Vehicle Navigation Application

Othman Maklouf, Abdurazag Ghila, Ahmed Abdulla, Ameer Yousef

**Abstract**—Land vehicle navigation system technology is a subject of great interest today. Global Positioning System (GPS) is a common choice for positioning in such systems. However, GPS alone is incapable of providing continuous and reliable positioning, because of its inherent dependency on external electromagnetic signals. Inertial Navigation is the implementation of inertial sensors to determine the position and orientation of a vehicle. As such, inertial navigation has unbounded error growth since the error accumulates at each step. Thus in order to contain these errors some form of external aiding is required. The availability of low cost Micro-Electro-Mechanical-System (MEMS) inertial sensors is now making it feasible to develop Inertial Navigation System (INS) using an inertial measurement unit (IMU), in conjunction with GPS to fulfill the demands of such systems. Typically IMU's are very expensive systems; however this INS will use "low cost" components. Unfortunately with low cost also comes low performance and is the main reason for the inclusion of GPS and Kalman filtering into the system. The aim of this paper is to develop a GPS/MEMS INS integrated system, which is able to provide a navigation solution with accuracy levels appropriate for land vehicle navigation. The primary piece of equipment used was a MEMS-based Crista IMU (from Cloud Cap Technology Inc.) and a Garmin GPS 18 PC (which is both a receiver and antenna). The integration of GPS with INS can be implemented using a Kalman filter in loosely coupled mode. In this integration mode the INS error states, together with any navigation state (position, velocity, and attitude) and other unknown parameters of interest, are estimated using GPS measurements. All important equations regarding navigation are presented along with discussion.

**Keywords**—GPS, IMU, Kalman Filter.

## I. INTRODUCTION

NAVIGATION has been present for thousands of years in some form or another. The birds, the bees, and almost everything else in nature must be able to navigate from one point in space to another [1]. For people, navigation had originally included using the sun and stars. Navigation comprises the methods and technologies to determine the time varying position and attitude of a moving object by measurement. Position, velocity, and attitude, when presented as time variable functions are called navigation states because they contain all necessary navigation information to geo-reference the moving object at that moment of time. A navigation sensor measures quantity related to one or more

elements of the navigation state such as Global Positioning System (GPS). A combination of sensors capable of determining all navigation states makes up a navigation system such as Inertial Navigation System (INS). A sensor that supplies only partial information on the navigation states or that is used as a constraint on some of the states will be called Navaid (such as odometers). [1] Inertial navigation is the determination of the position of a vehicle through the implementation of inertial sensors. It is based on the principle that an object will remain in uniform motion unless disturbed by an external force. This force in turn generates acceleration on the object. If this acceleration can be measured and then mathematically integrated, then the change in velocity and position of the object with respect to an initial condition can be determined. The inertial sensor which measures acceleration is known as an accelerometer. To measure the attitude, an inertial sensor known as a gyroscope is required. This sensor measures angular velocity, and if mathematically integrated provides the change in angle with respect to an initially known angle. The combination of accelerometers and gyros allows for the determination of the pose of the vehicle. An inertial navigation system usually contains three accelerometers, which are commonly mounted with their sensitive axes perpendicular to one another. The working theory of accelerometer is based on the Newton's laws. In order to navigate with respect to the inertial reference frame, it is necessary to keep track of the direction in which the accelerometers are pointing. Rotational motion of the body with respect to the inertial reference frame may be sensed using gyroscopic sensors and used to determine the orientation of the accelerometers at all times. Given this information, it is possible to transform the accelerations into the computation frame before the integration process takes place. At each time-step of the system's clock, the navigation computer time integrates this quantity to get the body's velocity vector. The velocity vector is then time integrated, yielding the position vector. Hence, inertial navigation is the process whereby the measurements provided by gyroscopes and accelerometers are used to determine the position of the vehicle in which they are installed. By combining the two sets of measurements, it is possible to define the translational motion of the vehicle within the inertial reference frame and to calculate its position within that frame.

## II. INERTIAL NAVIGATION

The basic principle of an INS is based on the integration of accelerations observed by the accelerometers on board the moving platform. The system will accomplish this task

O. Maklouf is with the Department of Electrical Engineering, Engineering Academy Tajoura, Libya, (e-mail: omaklouf@yahoo.com).

A. Ghila is with Department of Aeronautical Engineering, Engineering Academy Tajoura, Libya, (e-mail: arghila@gmail.com).

A. Abdulla and A. Yousef are with Department of Computer Engineering, Engineering Academy Tajoura, Libya, (e-mail: ahmohajer@yahoo.co.uk, omaklouf@yahoo.com).

through appropriate processing of the data obtained from the specific force and angular velocity measurements. Thus, an appropriately initialized inertial navigation system is capable of continuous determination of vehicle position, velocity and attitude without the use of the external information [1].

The principal advantage of using inertial units is that given the acceleration and angular rotation rate data in three dimensions, the velocity and position of the vehicle can be evaluated in any navigation frame. For land vehicles, a further advantage is that unlike wheel encoders, an inertial unit is not affected by wheel slip. However, the errors caused by bias, scale factors and non-linearity in the sensor readings cause an accumulation in navigation errors with time and furthermore inaccurate readings are caused by the misalignment of the unit's axes with respect to the local navigation frame. This misalignment blurs the distinction between the acceleration measured by the vehicles motion and that due to gravity, thus causing inaccurate velocity and position evaluation. Since an inertial unit is a dead reckoning sensor, any error in a previous evaluation will be carried onto the next evaluation, thus as time progresses the navigation solution drifts.

#### A. Inertial Systems

A package of inertial sensors is classified into one of three groups: An Inertial Sensor Assembly (ISA): In which the raw data from the inertial sensors is the only data output from the unit. An Inertial Measurement Unit (IMU): Is an ISA however the raw data output is compensated for errors such as scale factors and bias. An Inertial Navigation System (INS): Is an IMU however the output from the unit is fed to navigation algorithms so that the position, velocity, attitude and heading of the vehicle can be evaluated. The unit also provides the compensated raw data which can be used for control or stabilization purposes. INS systems are generally found in almost all forms of long distance aircraft and sea vessels, submarine and missile applications, and this is due to their initial wide spread use in military roles. In such applications the inertial sensors implemented have to be of supreme quality, providing stable readings, extremely high resolution and high-bandwidth.

The algorithms and electronics implemented are also of high quality in order to minimize the introduction of any errors. With the current trend to better navigation performance for civilian applications, INS systems can provide a useful sensor; however, current high accuracy INS systems are too expensive for land vehicle or robotic applications. The predominant cost derives from the type of inertial sensors being implemented and in particular that of the gyroscopes. Reducing the cost of these sensors through the type of materials being used, manufacturing process and through the actual physical implementation, in turn decreases the accuracy of the inertial system.

Fig. 1 The difference between ISA, IMU and INS

#### B. Physical Implementation

The first type of INS developed was a gimballed system the accelerometers are mounted on a gimballed. In a gimballed system the accelerometer triad is rigidly mounted on the inner gimbal of three gyros (see Fig. 2 (b)). The inner gimbal is isolated from the vehicle rotations and its attitude remains constant in a desired orientation in space during the motion of the system. The gyroscopes on the stable platform are used to sense any rotation of the platform, and their outputs are used in servo feedback loops with gimbal pivot torque actuators to control the gimbals such that the platform remains stable. These systems are very accurate, because the sensors can be designed for very precise measurements in a small measurement range.

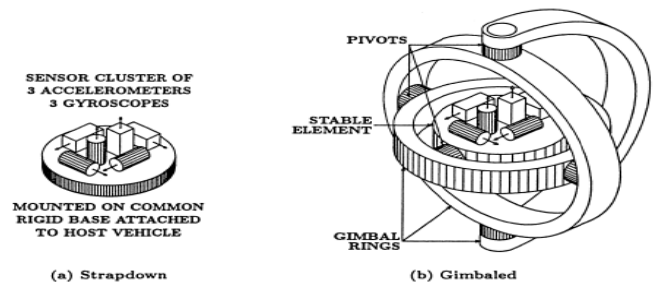

Fig. 2 Inertial Systems Arrangement

In contrary, a strap-down inertial navigation system uses orthogonal accelerometers and gyro triads rigidly fixed to the axes of the moving vehicle (Fig. 2 (a)). The angular motion of the system is continuously measured using the rate sensors. The accelerometers do not remain stable in space, but follow the motion of the vehicle. A strap-down system is a major hardware simplification of the old gimballed systems. The accelerometers and gyros are mounted in body coordinates and are not mechanically moved. Instead, a software solution is used to keep track of the orientation of the IMU (and vehicle) and rotate the measurements from the body frame to the navigational frame. This method overcomes the problems encountered with the gimballed system, and most importantly reduces the size, cost, power consumption, and complexity of the system.

#### C. Reference Frames Commonly Used in Inertial Navigation

These include the ECEF (Earth-Centered Earth-Fixed) frame (e frame), the local level frame (LLF) and the body

frame (b frame). The origin of the ECEF frame is the center of the Earth's mass. The X-axis is located in the equatorial plane and points towards the mean Meridian of Greenwich. The Y-axis is also located in the equatorial plane and is 90 degrees east of the mean Meridian of Greenwich. The Z-axis parallels the Earth's mean spin axis. LLF is a local geodetic frame serves as local reference directions for representing vehicle attitude and velocity for operation on or near the surface of the Earth; for this reason, it is often referred to as navigation frame (n-frame). A common orientation for LLF coordinates is the North-East-Up (NEU) system. The origin of the LLF frame is coincides with sensor frame. The Z-axis is orthogonal to the reference ellipsoid pointing up. The X-axis is pointing towards geodetic East. The Y-axis is pointing toward geodetic North.

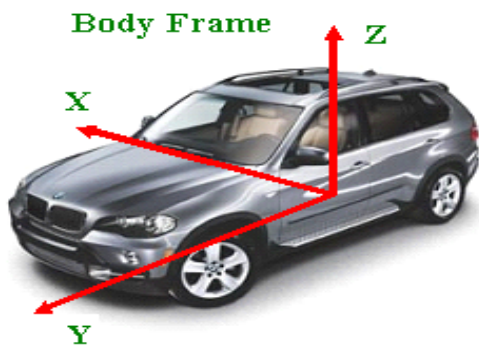

Fig. 3 Body Frame (b-frame)

The body frame (Fig. 3) represents the orientation of the IMU axes. The IMU sensitive axes are assumed to be approximately coincident with the moving platform upon which the IMU sensors are mounted. The origin of the body frame is at the center of the IMU. The X-axis points towards the right of the moving platform, the Y-axis points toward the front of the moving platform, and the Z-axis is orthogonal to the X and Y axes to complete a right-handed frame.

#### D. INS Mechanization Equation

The IMU measurements include three angular rate components provided by the gyroscopes and denoted by the 3x1 vector  $\omega_{nb}^b$  as well as three linear acceleration components provided by the accelerometers and denoted by the 3x1 vector  $f^b$ . This means that the angular velocities  $\omega_{nb}^b$  of the body frame are measured with respect to the inertial frame [7]-[9]. Fig. 4 shows a block diagram of INS mechanization algorithm.

$$\begin{pmatrix} \dot{r}^n \\ \dot{v}^n \\ \dot{q}_n^b \end{pmatrix} = \begin{pmatrix} D^{-1} v^n \\ C_b^n f^b - (2\omega_{ie}^n + \omega_{en}^n) \times v^n + g^n \\ \frac{1}{2} \Omega_{ib}^b q_n^b \end{pmatrix} \quad (1)$$

The DCM  $C_b^n$  is accomplished by using quaternion

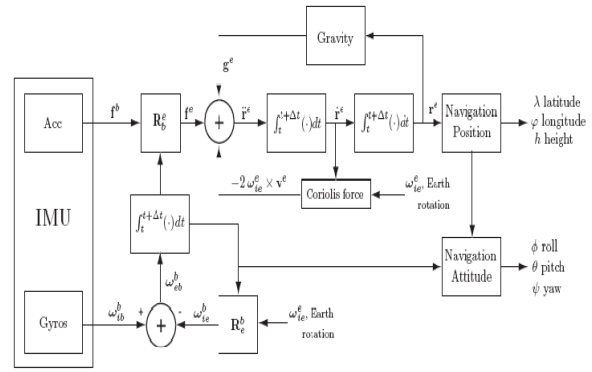

Fig. 4 INS Mechanization block diagram [4]

$$\begin{pmatrix} \dot{q}_0 \\ \dot{q}_1 \\ \dot{q}_2 \\ \dot{q}_3 \end{pmatrix} = \frac{1}{2} \begin{pmatrix} 0 & -\omega_x & -\omega_y & -\omega_z \\ \omega_x & 0 & \omega_z & -\omega_y \\ \omega_y & -\omega_z & 0 & \omega_x \\ \omega_z & \omega_y & -\omega_x & 0 \end{pmatrix} \begin{pmatrix} q_0 \\ q_1 \\ q_2 \\ q_3 \end{pmatrix} \quad (2)$$

$$C_b^n = \begin{pmatrix} q_1^2 + q_0^2 - q_2^2 - q_3^2 & 2(q_1 q_2 + q_3 q_0) & 2(q_1 q_3 - q_2 q_0) \\ 2(q_1 q_2 - q_3 q_0) & q_2^2 + q_0^2 - q_1^2 - q_3^2 & 2(q_2 q_3 + q_1 q_0) \\ 2(q_1 q_3 + q_2 q_0) & 2(q_2 q_3 - q_1 q_0) & q_3^2 + q_0^2 - q_1^2 - q_2^2 \end{pmatrix}^T \quad (3)$$

The Euler angles can also be determined from quaternion by the following [4]:

$$\theta = \sin^{-1}[-2(q_1 q_3 - q_0 q_2)] \quad (4)$$

$$\phi = \sin^{-1} \left[ \frac{2(q_2 q_3 + q_1 q_0)}{\cos(\theta)} \right] \quad (5)$$

$$\psi = \sin^{-1} \left[ \frac{2(q_1 q_2 + q_3 q_0)}{\cos(\theta)} \right] \quad (6)$$

### III. KALMAN FILTER

The Kalman filter was added to estimate the position, velocity and attitude of the system. The full Kalman filter equations will not be presented here due to limited space, but an overview of the process is shown in Fig. 5 and further information can be found in [3].

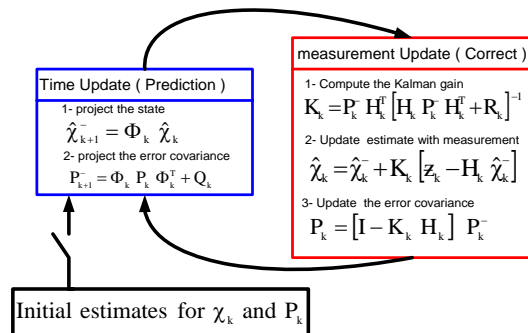

Fig. 5 Kalman filter algorithm

#### IV. INS ERROR DYNAMICS EQUATION

The INS error model is obtained by perturbing the mechanization equation (1) and is given by a series of first order differential equations. These error equations will be necessary to build the INS/GPS Kalman filters. The perturbation of position, velocity, and attitude can be expressed as

$$\delta \dot{r}^n = F_{RR} \delta r^n + F_{RV} \delta v^n \quad (7)$$

$$\delta \dot{v}^n = F_{VR} \delta r^n + F_{VV} \delta v^n + \delta C_b^n f^b + C_b^n \delta f^b \quad (8)$$

$$\delta C_b^n f^b = \delta C_b^n(\delta q, q_b^n) f^b \quad (9)$$

The system equation can be written in matrix form as follow

$$\chi_{k+1} = \Phi_k \chi_k + w_k \quad (10)$$

where:  $\chi_k$  is the state vector at time  $t_k$ ,  $\Phi_k$  is the state transition matrix at time  $t_k$ ,  $w_k$  is the vector of process noise at time  $t_k$ .

$$\chi_k = \begin{pmatrix} \delta r^n \\ \delta v^n \\ \delta \alpha_b^n \end{pmatrix} = [\delta \phi \ \delta \lambda \ \delta h \ \delta \alpha_N \ \delta \alpha_E \ \delta \alpha_D \ \delta \alpha_0 \ \delta \alpha_1 \ \delta \alpha_2 \ \delta \alpha_3]^T \quad (11)$$

$$u_k = \begin{pmatrix} \delta f^b \\ \delta \alpha_b^n \end{pmatrix} = [\delta f_x \ \delta f_y \ \delta f_z \ \delta \alpha_x \ \delta \alpha_y \ \delta \alpha_z]^T \quad (12)$$

$$\Phi_k = \begin{pmatrix} F_{RR} & F_{RV} & 0_{3 \times 4} \\ F_{VR} & F_{VV} & F_{VAQ} \\ 0_{4 \times 4} & 0_{4 \times 4} & F_{AAQ} \end{pmatrix}, \quad G_k = \begin{pmatrix} 0_{3 \times 3} & 0_{3 \times 3} \\ G_{AVQ} & 0_{3 \times 3} \\ 0_{4 \times 3} & G_{AAQ} \end{pmatrix} \quad (13)$$

#### V. HARDWARE

##### A. Crista IMU

The Crista Inertial Measurement Unit (Fig. 6) is a very small three axis inertial sensor that provides high resolution digital rate and acceleration data via serial interfaces from **Cloud Cap Technology**, (Crista Interface/Operation Document, 2004) [2].



Fig. 6 Cloud Cup Technology Crista IMU which is a very small, low-cost, 3-axis MEMS Inertial Measurement Unit

##### B. GARMIN GPS

The GPS system used in this work is the Garmin 18 LVS. Garmin is a common name in commercial civilian GPS systems, and this OEM device has performance that is on par with all other GPS systems available currently (i.e. accuracy of about 10m 95% of the time) [10]. Other errors are not location dependant.



Fig. 7 GPS 9 PC with DB-9 pin serial connector

#### VI. GPS\INS INTEGRATION TECHNIQUES

The concept of integrating GPS/INS has been well understood over the past decade. Different strategies for integration have been developed and tested with different grades of IMUs. Typically, three main strategies are defined, namely loose integration, tight integration and Ultra-tight (or deep) integration [5]. In this paper, the loosely integration strategy is used, Fig. 8 shows graphical block diagram of loosely coupled integration.

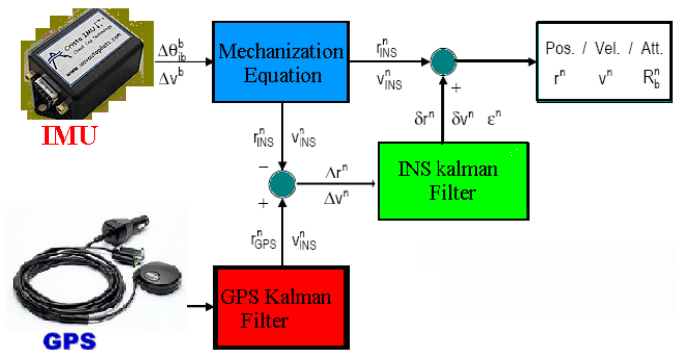

Fig. 8 GPS\INS in Loosely Integration Mode

In this integration scheme, GPS and inertial processing is carried out in two separate filters, but interacting, filters [6]. Together these constitute a decentralized filter process; hence, this strategy is also referred as a decentralized integration strategy. The GPS measurements are processed independently in a GPS-only Kalman filter. Then the output of this filter is used periodically as input to the INS-only filter. The INS-only filter uses the difference between the GPS-derived position and velocity estimates, and the INS mechanization-derived position and velocities as measurements to obtain the error estimates. The position/velocity covariance matrix is transferred from the GPS-only filter to the INS master filter as the measurement noise.

## VII. EXPERIMENTAL SETUP AND RESULTS

The experimental work is divided into two main parts. The first part is the navigation solution using stand alone IMU without the Kalman filter or the GPS positional corrections. In the second part the Kalman filter and GPS were introduced to the system in order to show their impact to overcome the limitation of the IMU.

### A. Test Setup

The experiments were conducted using a car with the IMU and GPS mount on it. A laptop was connected to both sensors and recorded the data. To perform this experiment a trajectory was selected as shown in the following picture (Fig. 9) which will be used as a reference trajectory; this picture is taken using Google earth. The data was then taken and analyzed in Matlab using the proceeding equations.



Fig. 9 Selected area for the experimental setup

### B. GPS Only Solution

In order to assess the performance of the integrated system, it is necessary to examine the performance of the aiding source, which is primarily GPS sensor. Thus, this section quantifies the accuracy of the navigation solution available from the GPS 18 receiver. Fig. 10 shows the estimated trajectory as derived from the GPS sensor. The corresponding output velocities of the derived trajectory are given in Fig. 11.

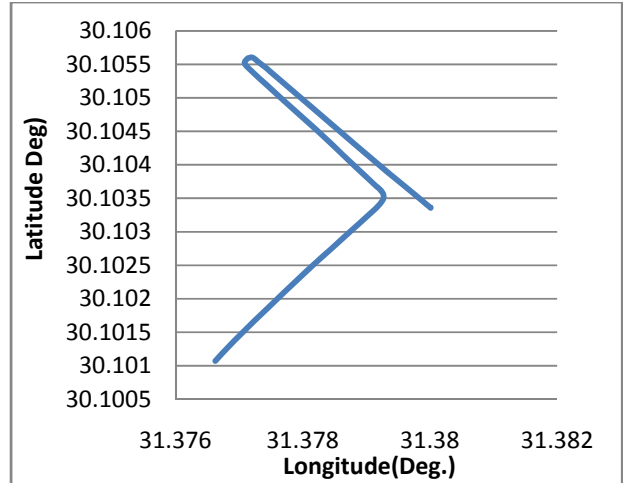
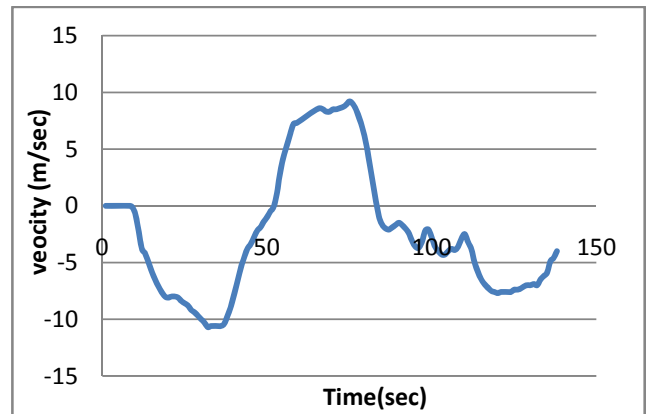
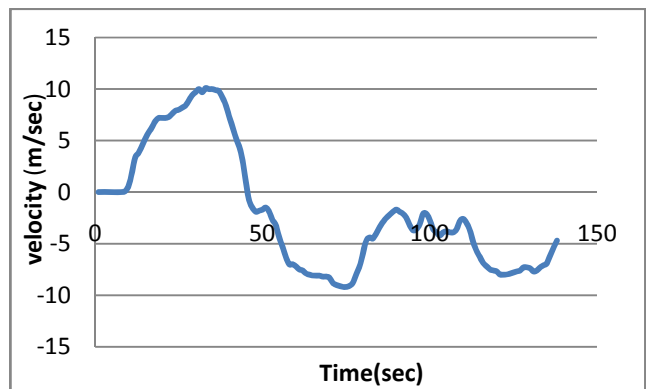

Fig. 10 Vehicle trajectory as estimated by GPS



(a)



(b)

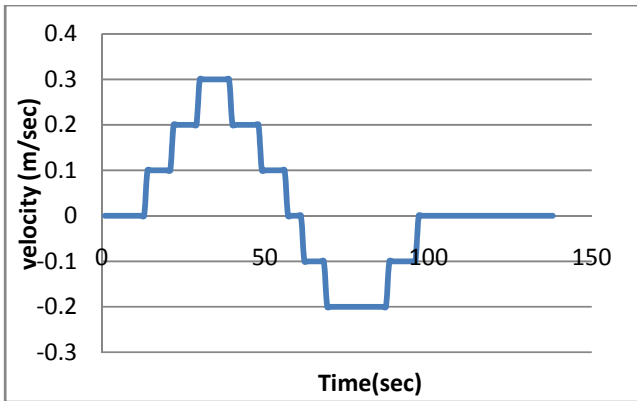

(c)

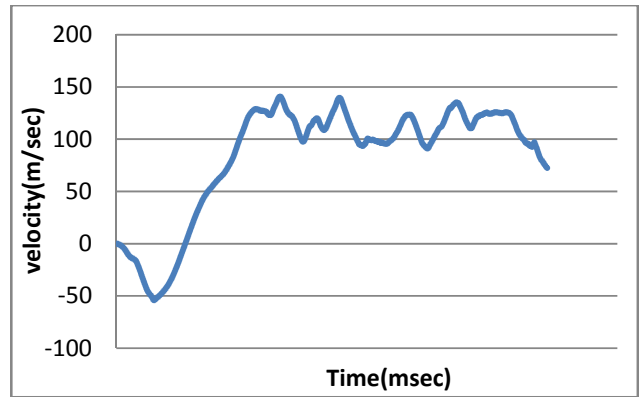

(a)

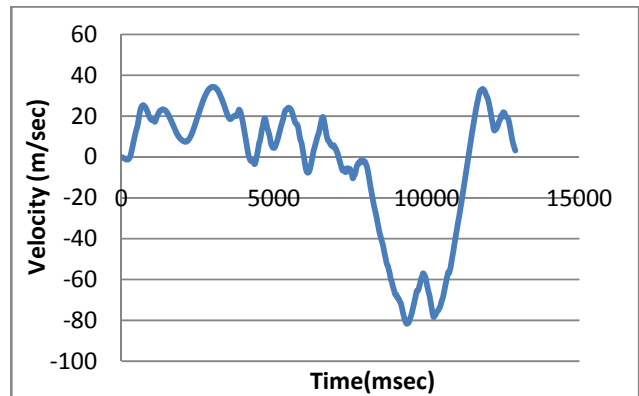

(b)

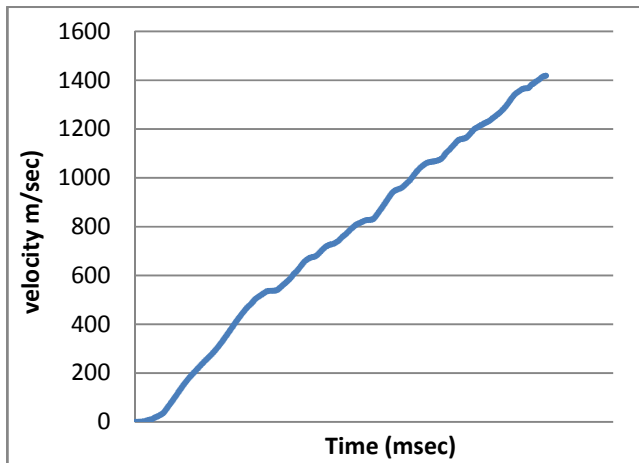

(c)

Fig. 11 North, East, and Vertical velocities respectively estimated by GPS

*C. INS Navigation Solution Only*

To examine the performance of the IMU the first set of results was done without the use of the Kalman filter and GPS (stand alone mode). The resulting INS navigation solution (position and attitude) without any corrections are shown in Figs. 12 and 13 respectively. It is clear that performing navigation using stand alone MEMS IMU shows that the performance is largely degraded with time; this is of course due to the accumulation of the noisy measurements of acceleration and angular rate. When we look at Fig. 13 the GPS (working alone) GPS provides good results compared to stand alone INS but it is only gives positioning in low rate (every 1 sec).

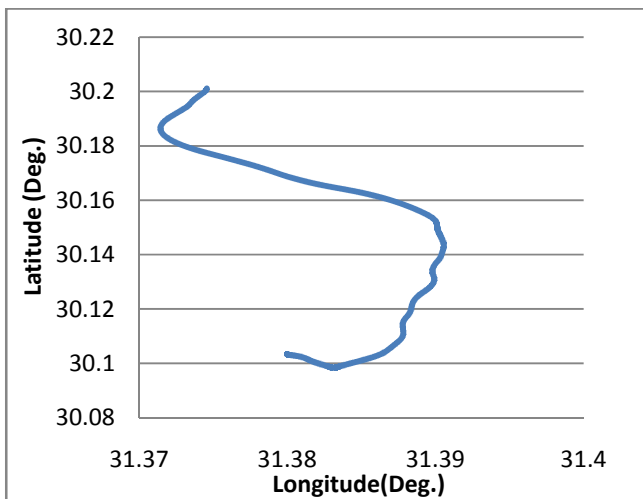

Fig. 12 Vehicle trajectory as estimated by INS

Fig. 13 North, East, and Vertical velocities respectively estimated by INS

*D. GPS/INS Integration Using Kalman Filter*

After the inclusion of the GPS and Kalman filter, the plots shown in Figs. 14 and 15 are much better. From Fig. 14 it is clear that the GPS and INS lie right on top of each other. Taking a closer look at Fig. 15 shows that the two do not really lie exactly on top, but rather the INS transitions smoothly through the GPS points.



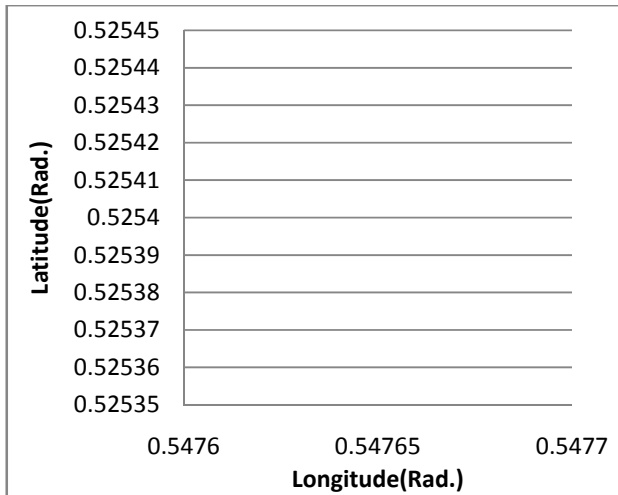

Fig. 14 Vehicle trajectory as estimated by GPS\INS

- [5] Saurabh Godha., "Performance Evaluation of Low Cost MEMS-Based IMU Integrated With GPS for Land Vehicle Navigation Application" Masters Thesis, the University of Calgary, Department of Geomatics Engineering, Calgary. FEBRUARY, 2006.
- [6] El-Sheimy. "Inertial techniques and INS/DGPS Integration". ENGO 623- Lecture Notes, the University of Calgary, Department of Geomatics Engineering, Calgary (2004).
- [7] Walchko, K. and Mason, P., "Inertial Navigation," 2002 FCRR, FIT, Miami, 2002.
- [8] 8. Sukkariéh, S., "Low Cost, High Integrity, Aided Inertial Navigation Systems for Autonomous Land Vehicles," Ph.D. Thesis, University of Sydney, March 2000.
- [9] Walchko, K., "Low Cost Inertial Navigation," Masters' Thesis, University of Florida, August 2002.
- [10] GPS 18 Technical Specifications (190-00307-00). <http://www.gpsinformation.net/waasgps.htm>.

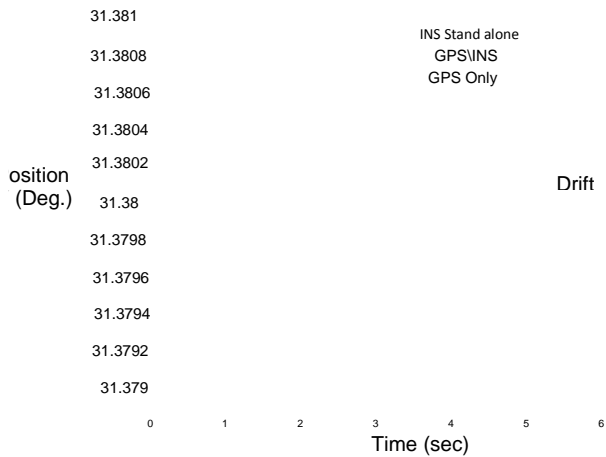

Fig. 15 The effect of integrating Crista IMU and GPS 18PC sensor using Kalman filter in trajectory estimation

### VIII.CONCLUSION

This paper has shown the effective combination of two different sensors (GPS and IMU) each with their own strengths and weaknesses. The "low cost" IMU used in this work is not capable of running by itself and providing any reasonable positioning information. GPS provides good results, but is only capable of determining position every second. The two sensors combined has the capability of Producing good estimates of position in between the one Second updates.

### REFERENCES

- [1] Mohander S. Grewal, Lawrance R. Weill, Angus P. Anderws "Global positioning system inertial navigation system and integration," Copyright © 2001 A JohnWiley &Sons, Inc.
- [2] Crista- Interface/Operation Document, 2004. Crista Inertial Measurement Unit (IMU) Interface / Operation Document. A Cloud Cap Technology Inc.
- [3] Greg Welch, An Introduction to the Kalman Filter. Gary Bishop University: University of North Carolina at Chapel Hill Department of Computer Science Chapel Hill, NC 27599-3175.
- [4] Eun-Hwan Shin, "Estimation Techniques for Low -Cost Inertial Navigation" Ph.D. Thesis, University of Calgary, May 2005.